



Spreader beam, non-adjustable model TTS-E

Capacity 1000 - 10000 kg

Tigrip spreader beams are the practical and safe choice for either long material to prevent sagging and shifting, or for loads where the weight has to be carefully distributed or suspended from several points. The extensive standard program offers a wide variety of capacities, working widths, adjustable ranges and hooks for common applications.

This heavy-duty and cost-effective standard type is complemented by various customized designs. These may be spreader beams with hooks for plate material, or with C-hooks, crane forks, or grabs for bulky and long materials.

Special designs with laterally fixed hooks are fitted with slings to pick up rolls, pipes and similar objects. Also available are the so-called "star" spreader beams for picking up cylindrical materials or spreader beams with side hooks and 4-point support which share the easy operation, reliability and safety of all Tigrip spreader beams.

! Customised models see page 212-213.

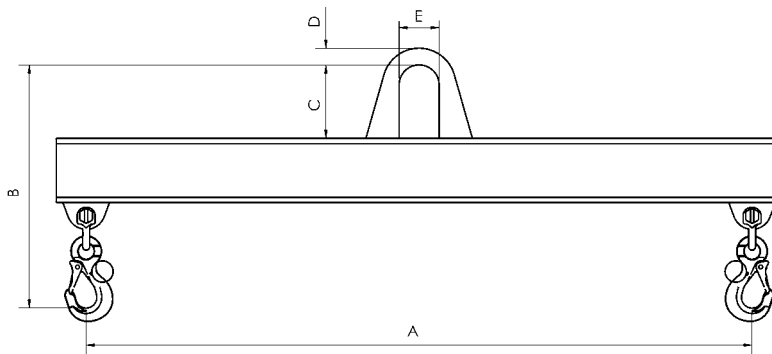

Technical data model TTS-E

Model	EAN-No. 4025092*	Capacity kg	Working width A mm	Hook mouth mm	Weight kg
TTS 1,0/1000 E	*552905	1000	1000	23	23
TTS 2,0/1000 E	*554534	2000	1000	23	25
TTS 3,0/1000 E	*552813	3000	1000	30	28
TTS 5,0/1000 E	*554541	5000	1000	38	41
TTS 7,5/1000 E	*554558	7500	1000	42	50
TTS 10,0/1000 E	*554565	10000	1000	42	61
TTS 1,0/1500 E	*552851	1000	1500	23	31
TTS 2,0/1500 E	*554572	2000	1500	23	33
TTS 3,0/1500 E	*552028	3000	1500	30	41
TTS 5,0/1500 E	*552172	5000	1500	38	64
TTS 7,5/1500 E	*554589	7500	1500	42	74
TTS 10,0/1500 E	*554596	10000	1500	42	90
TTS 1,0/2500 E	*554602	1000	2500	23	46
TTS 2,0/2500 E	*552769	2000	2500	23	69
TTS 3,0/2500 E	*552202	3000	2500	30	88
TTS 5,0/2500 E	*552493	5000	2500	38	106
TTS 7,5/2500 E	*554619	7500	2500	42	148
TTS 10,0/2500 E	*554626	10000	2500	42	181
TTS 1,0/3500 E	*554633	1000	3500	23	77
TTS 2,0/3500 E	*554640	2000	3500	23	118
TTS 3,0/3500 E	*552592	3000	3500	30	138
TTS 5,0/3500 E	*554657	5000	3500	38	167
TTS 7,5/3500 E	*554664	7500	3500	42	235
TTS 10,0/3500 E	*554671	10000	3500	42	272
TTS 1,0/5000 E	*554688	1000	5000	23	163
TTS 2,0/5000 E	*552523	2000	5000	23	189
TTS 3,0/5000 E	*554695	3000	5000	30	223
TTS 5,0/5000 E	*554701	5000	5000	38	295
TTS 7,5/5000 E	*554718	7500	5000	42	372
TTS 10,0/5000 E	*554725	10000	5000	42	478

Dimensions model TTS-E

Model	TTS 1,0/1000 E	TTS 2,0/1000 E	TTS 3,0/1000 E	TTS 5,0/1000 E	TTS 7,5/1000 E	TTS 10,0/1000 E	TTS 1,0/1500 E	TTS 2,0/1500 E	TTS 3,0/1500 E	TTS 5,0/1500 E
B, mm	375	400	470	585	690	770	375	400	490	605
C, mm	110	135	160	180	200	260	110	135	160	180
D, mm	25	30	35	40	60	70	25	30	35	40
E, mm	60	75	90	100	130	130	60	75	90	100

Model	TTS 7,5/1500 E	TTS 10,0/1500 E	TTS 1,0/2500 E	TTS 2,0/2500 E	TTS 3,0/2500 E	TTS 5,0/2500 E	TTS 7,5/2500 E	TTS 10,0/2500 E	TTS 1,0/3500 E	TTS 2,0/3500 E
B, mm	710	790	375	440	530	625	750	830	405	460
C, mm	200	260	110	135	160	180	200	260	110	135
D, mm	60	70	25	30	35	40	60	70	25	30
E, mm	130	130	60	75	90	100	130	130	60	75

Model	TTS 3,0/3500 E	TTS 5,0/3500 E	TTS 7,5/3500 E	TTS 10,0/3500 E	TTS 1,0/5000 E	TTS 2,0/5000 E	TTS 3,0/5000 E	TTS 5,0/5000 E	TTS 7,5/5000 E	TTS 10,0/5000 E
B, mm	550	665	770	850	445	480	570	685	790	890
C, mm	160	180	200	260	110	135	160	180	200	260
D, mm	35	40	60	70	25	30	35	40	60	70
E, mm	90	100	130	130	60	75	90	100	130	130



Spreader beam, adjustable model TTS

Capacity 1000 - 25000 kg

Technical data model TTS

Model	EAN-No. 4025092*	Capacity kg	Working width Z mm	Hook mouth mm	Weight kg
TTS 1,0/1500	*552646	1000	700 - 1500	18	40
TTS 2,0/1500	*552295	2000	700 - 1500	18	41
TTS 3,0/1500	*553988	3000	700 - 1500	21	53
TTS 5,0/1500	*551281	5000	700 - 1500	23	79
TTS 7,5/1500	*553995	7500	700 - 1500	32	98
TTS 10,0/1500	*552219	10000	700 - 1500	32	117
TTS 12,5/1500	*554008	12500	700 - 1500	40	116
TTS 15,0/1500	*554015	15000	700 - 1500	40	137
TTS 20,0/1500	*554022	20000	700 - 1500	50	180
TTS 25,0/1500	*554039	25000	700 - 1500	50	226
TTS 1,0/2500	*554046	1000	1500 - 2500	18	58
TTS 2,0/2500	*552158	2000	1500 - 2500	18	84
TTS 3,0/2500	*552448	3000	1500 - 2500	21	105
TTS 5,0/2500	*552424	5000	1500 - 2500	23	127
TTS 7,5/2500	*554053	7500	1500 - 2500	32	178
TTS 10,0/2500	*554060	10000	1500 - 2500	32	215
TTS 12,5/2500	*554077	12500	1500 - 2500	40	198
TTS 15,0/2500	*554084	15000	1500 - 2500	40	237
TTS 20,0/2500	*554091	20000	1500 - 2500	50	287
TTS 25,0/2500	*554107	25000	1500 - 2500	50	342
TTS 1,0/3500	*552684	1000	1700 - 3500	18	95
TTS 2,0/3500	*554114	2000	1700 - 3500	18	137
TTS 3,0/3500	*554121	3000	1700 - 3500	21	162
TTS 5,0/3500	*554138	5000	1700 - 3500	23	228
TTS 7,5/3500	*554145	7500	1700 - 3500	32	278
TTS 10,0/3500	*554152	10000	1700 - 3500	32	317
TTS 12,5/3500	*554169	12500	1700 - 3500	40	295
TTS 15,0/3500	*551403	15000	1700 - 3500	40	340
TTS 20,0/3500	*554176	20000	1700 - 3500	50	451
TTS 25,0/3500	*554183	25000	1700 - 3500	50	512
TTS 1,0/5000	*554367	1000	2000 - 5000	18	190
TTS 2,0/5000	*554374	2000	2000 - 5000	18	219
TTS 3,0/5000	*554381	3000	2000 - 5000	21	260
TTS 5,0/5000	*554398	5000	2000 - 5000	23	372
TTS 7,5/5000	*554404	7500	2000 - 5000	32	423
TTS 10,0/5000	*554411	10000	2000 - 5000	32	531
TTS 12,5/5000	*554428	12500	2000 - 5000	40	449
TTS 15,0/5000	*554435	15000	2000 - 5000	40	568
TTS 20,0/5000	*554442	20000	2000 - 5000	50	691
TTS 1,0/8000	*554459	1000	3000 - 8000	18	342
TTS 2,0/8000	*554466	2000	3000 - 8000	18	458
TTS 3,0/8000	*554473	3000	3000 - 8000	21	547
TTS 5,0/8000	*554480	5000	3000 - 8000	23	788
TTS 7,5/8000	*554497	7500	3000 - 8000	32	883
TTS 10,0/8000	*554503	10000	3000 - 8000	32	1319
TTS 12,5/8000	*554510	12500	3000 - 8000	40	979
TTS 15,0/8000	*554527	15000	3000 - 8000	40	1046

Dimensions model TTS

Model	TTS 1,0/1500	TTS 2,0/1500	TTS 3,0/1500	TTS 5,0/1500	TTS 7,5/1500	TTS 10,0/1500	TTS 12,5/1500	TTS 15,0/1500	TTS 20,0/1500	TTS 25,0/1500
B, mm	410	440	540	625	710	805	835	880	990	1200
C, mm	110	135	160	180	200	260	260	260	260	300
D, mm	25	30	35	40	60	70	75	85	90	100
E, mm	60	75	90	100	130	130	140	140	160	160

Model	TTS 1,0/2500	TTS 2,0/2500	TTS 3,0/2500	TTS 5,0/2500	TTS 7,5/2500	TTS 10,0/2500	TTS 12,5/2500	TTS 15,0/2500	TTS 20,0/2500	TTS 25,0/2500
B, mm	410	475	580	645	755	850	885	925	1030	1225
C, mm	110	135	160	180	200	260	260	260	260	300
D, mm	25	30	35	40	60	70	75	85	90	100
E, mm	60	75	90	100	130	130	140	140	160	160

Model	TTS 1,0/3500	TTS 2,0/3500	TTS 3,0/3500	TTS 5,0/3500	TTS 7,5/3500	TTS 10,0/3500	TTS 12,5/3500	TTS 15,0/3500	TTS 20,0/3500	TTS 25,0/3500
B, mm	410	500	605	685	780	875	905	950	1085	1270
C, mm	110	135	160	180	200	260	260	260	260	300
D, mm	25	30	35	40	60	70	75	85	90	100
E, mm	60	75	90	100	130	130	140	140	160	160

Model	TTS 1,0/5000	TTS 2,0/5000	TTS 3,0/5000	TTS 5,0/5000	TTS 7,5/5000	TTS 10,0/5000	TTS 12,5/5000	TTS 15,0/5000	TTS 20,0/5000
B, mm	465	520	625	710	800	920	950	995	1125
C, mm	110	135	160	180	200	260	260	260	260
D, mm	25	30	35	40	60	70	75	85	90
E, mm	60	75	90	100	130	130	140	140	160

Model	TTS 1,0/8000	TTS 2,0/8000	TTS 3,0/8000	TTS 5,0/8000	TTS 7,5/8000	TTS 10,0/8000	TTS 12,5/8000	TTS 15,0/8000
B, mm	485	560	670	755	865	980	1015	1055
C, mm	110	135	160	180	200	260	260	260
D, mm	25	30	35	40	60	70	75	85
E, mm	60	75	90	100	130	130	140	140

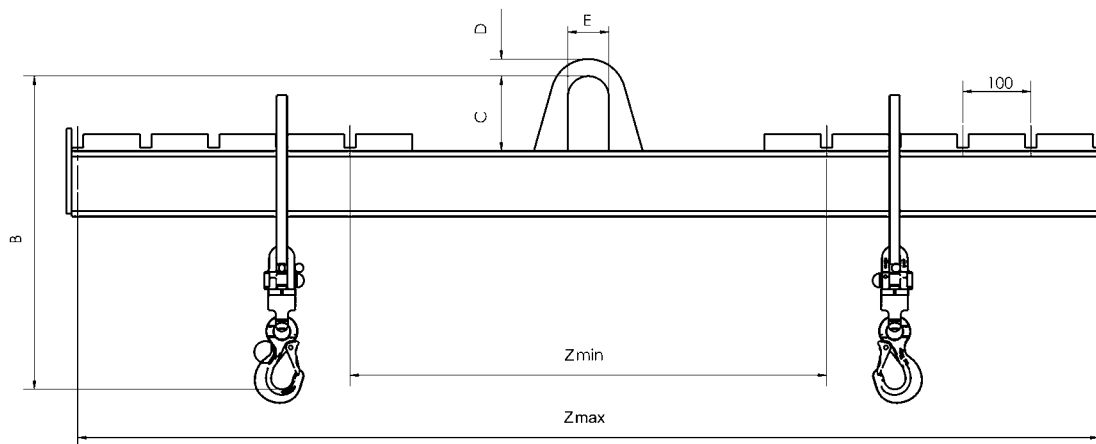

Customized spreader beams

Quick overview of our extensive program

Spreader beams are required in the most different versions and designs.

The illustrations given on these pages reflect a brief overview of the multitude of various spreader beam versions.

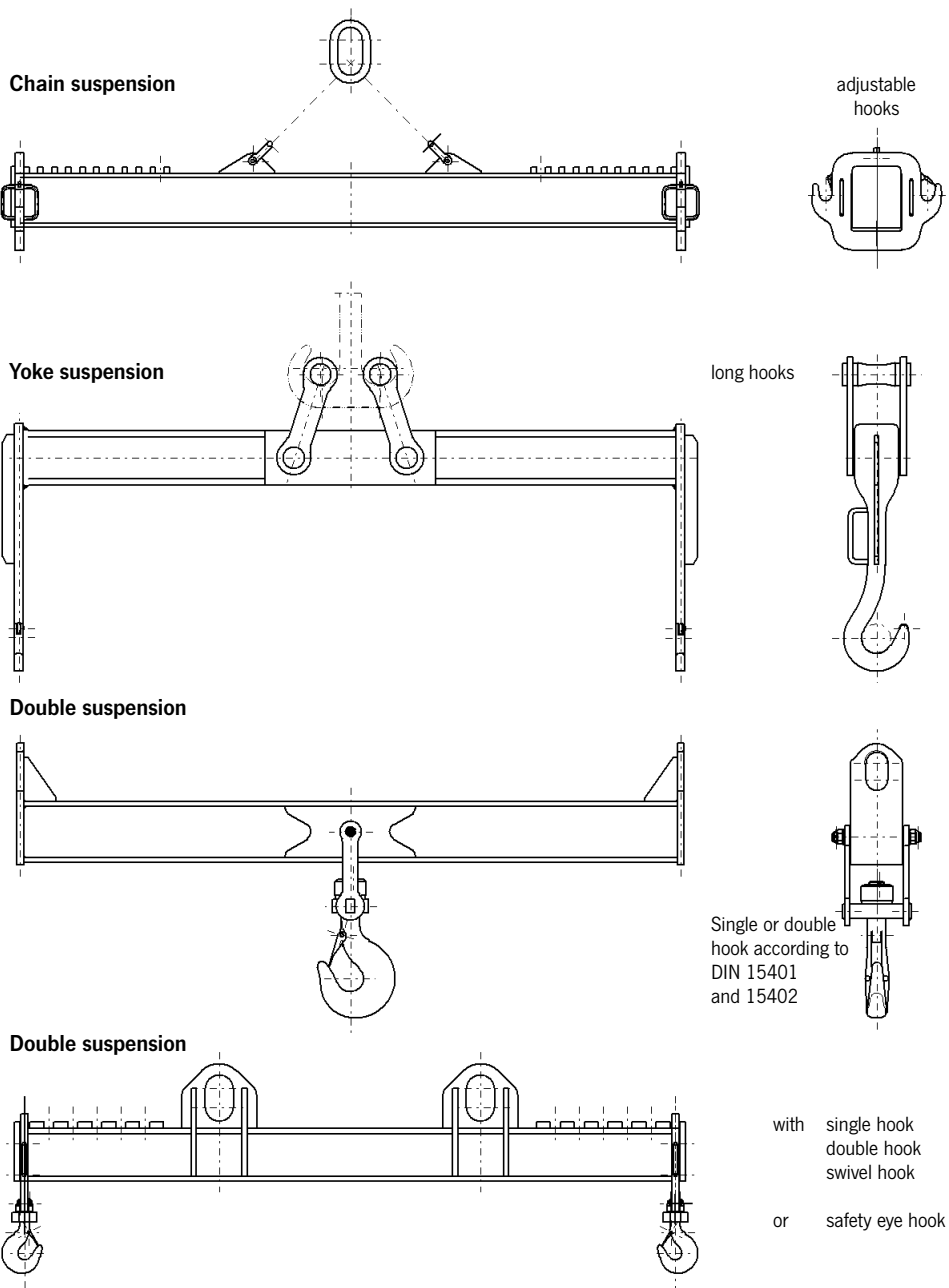

Standard spreader beams

Hooks with safety latch

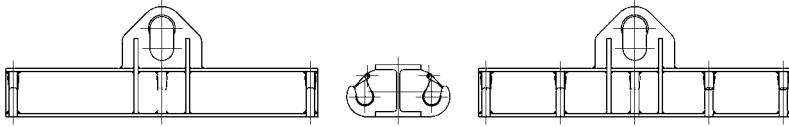

Hooks with safety latch adjustable

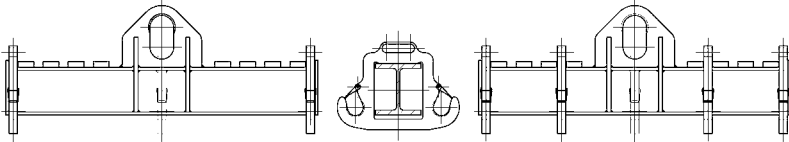

Safety eye hooks pivoting

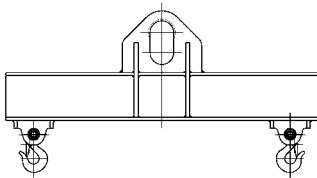

with swivel hooks swivelling and pivoting

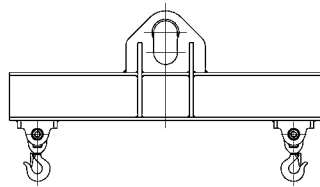

with long hooks fixed or adjustable

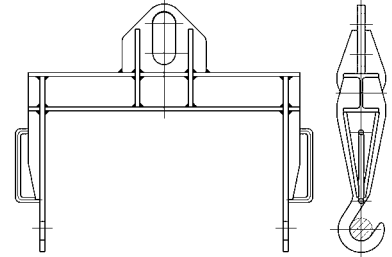

Safety eye hooks pivoting and adjustable

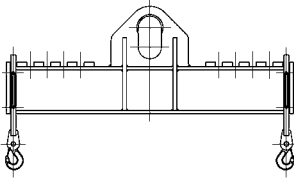

with swivel hooks swivelling, pivoting and adjustable

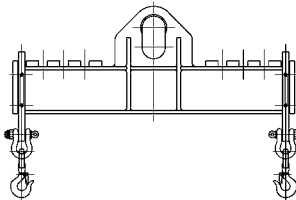

Spreader beams with side hooks

Safety eye hooks pivoting

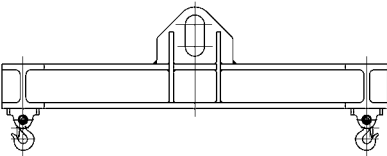

fixed

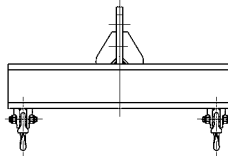

Swivel hooks swivelling, pivoting and adjustable

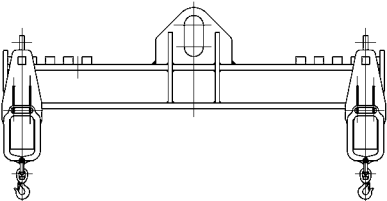

adjustable

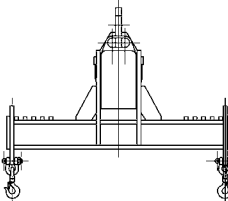



Spreader beam for box pallets model TTS

Capacity 1000 - 3000 kg

Box pallets with DIN 15155 specifications, are usually moved around with a forklift, but are so sturdy that they can be picked up and transported with a spreader beam grab and an overhead crane hooked up to the top of the box pallet's frame.

Thanks to these spreader beams, the shipping and receiving area is no longer entirely dependent on floor-level material handling equipment such as forklifts.

The version designed for the individual transport of box pallets is equipped with two fixed yokes and two pivoted ones, interconnected with a control bar. The load tackling gear is fixed and unfixable by only one person.

When using these spreader beams, it is important that the hooks be fastened only to the top frame of the box pallets.

Technical data model TTS

Model	EAN-No. 4025092*	Capacity kg	Weight kg
TTS 1,0/1240 - 810	*551595	1000	38
TTS 2,0/1240 - 810	*551236	2000	61
TTS 3,0/1240 - 810	*553742	3000	80

Dimensions model TTS

Model	TTS 1,0/1240 - 810	TTS 2,0/1240 - 810	TTS 3,0/1240 - 810
A, mm	1175	1175	1175
B, mm	600	600	600
C, mm	410	495	520
D, mm	195	215	215
E, mm	125	180	205
F, mm	100	150	170
G, mm	80	100	130
H, mm	28	30	40
I, mm	15	20	25

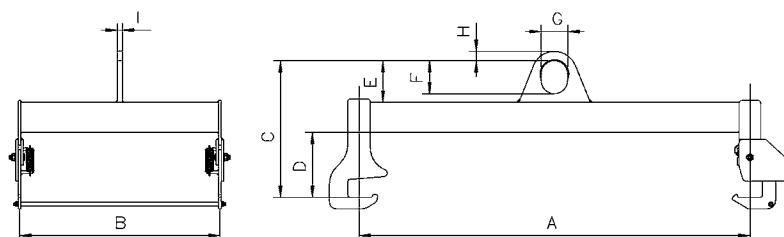

Spreader beam for Big-Bags model TTB

Capacity 1000 - 2000 kg

This four-point spreader beam in a fixed frame construction with weld-on hooks and safety latch is designed for lifting and transporting of Big-Bags.



Technical data model TTB

Model	EAN-No. 4025092*	Capacity kg	Working width Z mm	Weight kg
TTB 1,0/1090 - 1090	*556293	1000	750 - 800	27
TTB 1,0/1320 - 1320	*556316	1000	900 - 970	33
TTB 2,0/1090 - 1090	*556330	2000	750 - 800	42
TTB 2,0/1320 - 1320	*556354	2000	900 - 970	44

Dimensions model TTB

Model	TTB 1,0/1090 - 1090	TTB 1,0/1320 - 1320	TTB 2,0/1090 - 1090	TTB 2,0/1320 - 1320
B, mm	210	210	240	240
C, mm	60	60	75	75
D, mm	110	110	135	135

